



USER'S MANUAL

WinSimApp

Turnkey Instruments Ltd.

June, 2017



User's Manual Authorization Memorandum

I have carefully assessed the User's Manual for WinSimApp. This document has been completed in accordance with the requirements of the Turnkey Instruments Development Methodology.

MANAGEMENT CERTIFICATION - Please check the appropriate statement.

_____ The document is accepted.

_____ The document is accepted pending the changes noted.

_____ The document is not accepted.

We fully accept the changes as needed improvements and authorize initiation of work to proceed. Based on our authority and judgment, the continued operation of this system is authorized.

Mike Leck
Managing Director

DATE

Dave Brooks
General Manager

DATE

Alan Taylor
Director

DATE

USER'S MANUAL

TABLE OF CONTENTS

	<u>Page #</u>
1.0 GENERAL INFORMATION	1
1.1 WinSimApp Overview.....	1
1.2 Authorized Use Permission	1
1.3 Points of Contact.....	1
1.3.1 Information/Help Desk	1
1.4 Organization of the Manual	1
2.0 SYSTEM SUMMARY	2
2.1 System Architecture.....	2
2.2 Data Flows	2
2.3 User Access	2
2.4 Contingencies and Alternate Modes of Operation.....	2
3.0 GETTING STARTED	4
3.1 Logging On.....	4
3.2 Main Panel	4
3.3 Logout System.....	4
4.0 USING WINSIMAPP	8
4.1 Bluetooth Download.....	8
4.2 USB Download	9
4.3 Generate Report	10
4.4 Upload to Cloud.....	11
4.6 Exit.....	11
4.7 Caveats and Exceptions.....	11

1.0 GENERAL INFORMATION

1.0 GENERAL INFORMATION

1.1 WinSimApp Overview

The purpose of this application is to collect brake test data via Bluetooth or USB (OTG) cable from the Turnkey's brake testers (such as Simret 4000, Simret F2, etc.) into your handheld device. The application stores brake test data in the local database which can be searched later and analysed. The application also displays the time series in a dynamic graph. You can also generate brake test reports in PDF and send them to WiFi printer to obtain a hard copy. Using WinSimApp, the brake test data can also be uploaded to the cloud database which can be imported into the desktop WinSim program and used on the PC locally.

1.2 Authorized Use Permission

Usage of this software is limited to its owner via the terms of its development. WinSimApp is wholly owned by Turnkey Instruments Ltd. and may not be updated or amended without their express consent.

1.3 Points of Contact

1.3.1 Information/Help Desk

For additional information and/or support Turnkey Instruments Ltd. can be contacted via email rishad.ali@turnkey-instruments.com or phone (+44) 1606 339715.

1.4 Organization of the Manual

Section 2 describes the system architecture of the application including the data flow. Section 3 explains the log in/out operations and the main panel of the application. Section 4 gives details on how to use the application with the help of screenshots.

2.0 SYSTEM SUMMARY

2.0 SYSTEM SUMMARY

WinSimApp connects to the Turnkey brake testers via Bluetooth or USB (On The Go) cable to collect data from the instruments. The application can also be used to visualise the historic data from the WinSim cloud database.

2.1 System Architecture

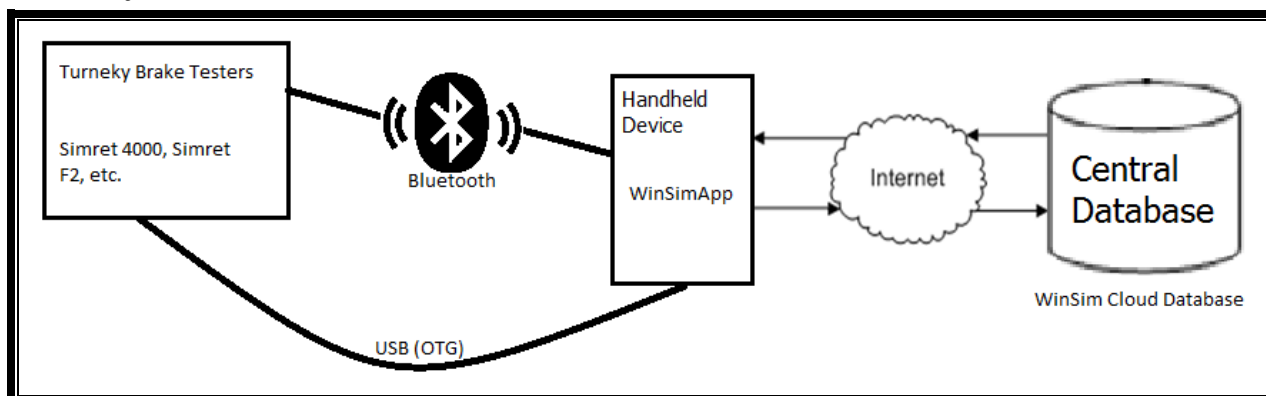

Figure 2.1

2.2 Data Flows

The above diagram shows how WinSimApp interacts with Turnkey brake testers and the WinSim data centre. The data flow in the architecture is as follows:

1. WinSimApp collects the login data from the central database to allow the user to login using their WinSim login details.
2. The application then shows the list of the registered instruments in their account.
3. It starts wired/wireless communication with the Turnkey brake testers to collect data from the instruments.
4. WinSimApp stores the data in a database locally in the mobile device.
5. It then uploads the collected data to the cloud database (if the internet connection is available).

2.3 User Access

WinSim login details can be used to log in to WinSimApp. You must have a WinSim account to use this application as the instruments are only registered in the WinSim account. You can request Turnkey to create a WinSim account and register instruments for you, if you don't already have one, via email to techsupport@turnkey-instruments.com

2.4 Contingencies and Alternate Modes of Operation

In case the WinSim server goes down the app will not be able to upload the data to the cloud database but the instruments can continue to collect data and save into the local database and the locally stored data can be uploaded to the cloud database at later stage.

3.0 GETTING STARTED

3.0 GETTING STARTED

3.1 Logging On

When you start the WinSimApp for the first time after installation, the first window appears on the screen is the login window where you can enter the login details to start using the application. The login screen shows two text boxes where you can enter user ID and password. It also allows you to make the password visible to make sure what you type is correct.

3.2 Main Panel

Once you have logged in successfully, the app shows the main panel when you open the app. This screen has the main features available in the app as shown in the figure below.

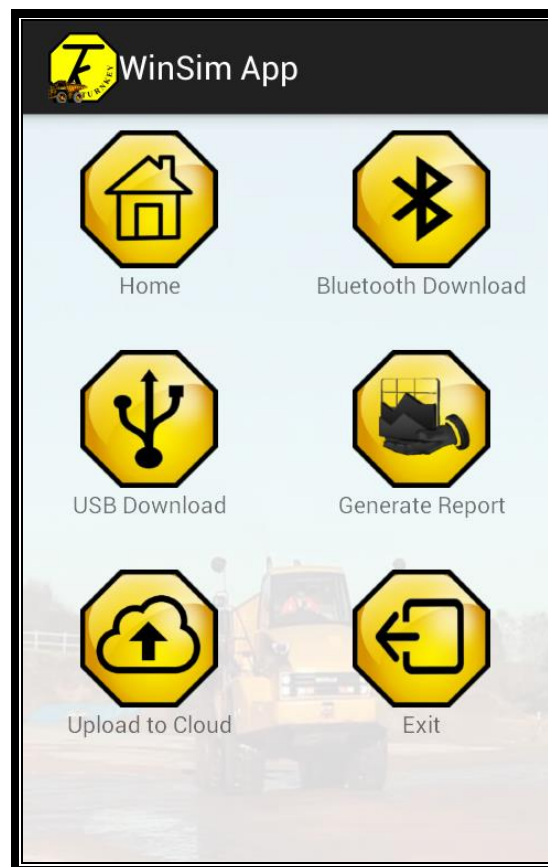

Figure 3.1

Each option is explained in detail in section 4.

3.3 Logout System

You can click **Log out** link in the options to logout from your account.

4.0 USING WINSIMAPP

4.0 USING WINSIMAPP

This section explains all the main panel options in detail with the help of screenshots.

4.1 Bluetooth Download

This option allows you to collect the data from the instruments via Bluetooth. When you select this option, the application shows you the list of the instruments registered in your WinSim account as shown in figure 4.1

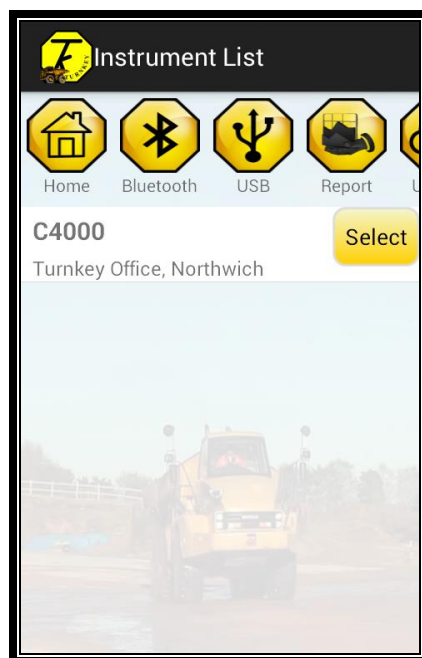

Figure 4.1

When you select an instrument from the list, the app automatically tries to connect to the instrument's Bluetooth. The instrument's Bluetooth must be paired with mobile device's Bluetooth to communicate. If the instrument's Bluetooth is not paired, then Click the '**Pair Device**' button and scan for the instrument, (use PIN = 1234 to pair with the device). Once the Bluetooth is paired, click '**List Devices**' button to show the list of paired devices and select the instrument ID to establish a Bluetooth connection. When the Bluetooth connection is established, the '**Download Data**' button will be enabled. Click Download data button and select if you wish to download the Time series or not. If you want to show the graph in the report, you must download time series (this process will take longer). If you wish to download only the test report without a graph, select 'No' when you are asked to download time series. Once the data collection process is completed, WinSimApp will show the summary of the data download as shown in figure 4.2.

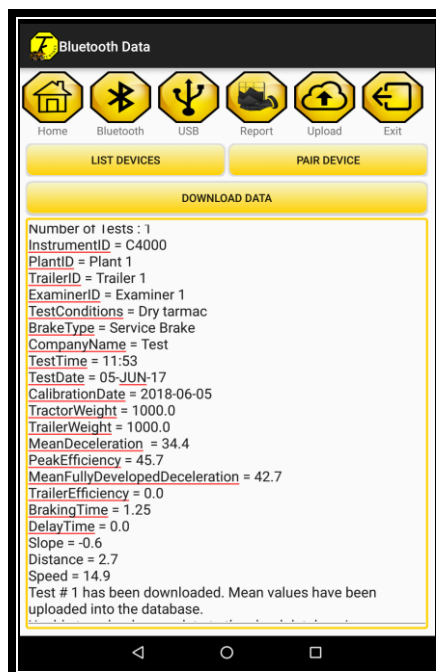

Figure 4.2

4.2 USB Download

This option allows you to download the data via USB (On The Go) cable. You can connect the Turnkey brake tester with your mobile device via a USB cable (which comes with the brake tester) with the help of [OTG](#) cable. Once you have connected your instrument with the mobile device via USB+OTG cable, select an instrument from the list and click 'Download Data' button to download all the data from the instrument into the mobile device. After the data download process is completed, the app shows a summary as shown in the figure 4.3

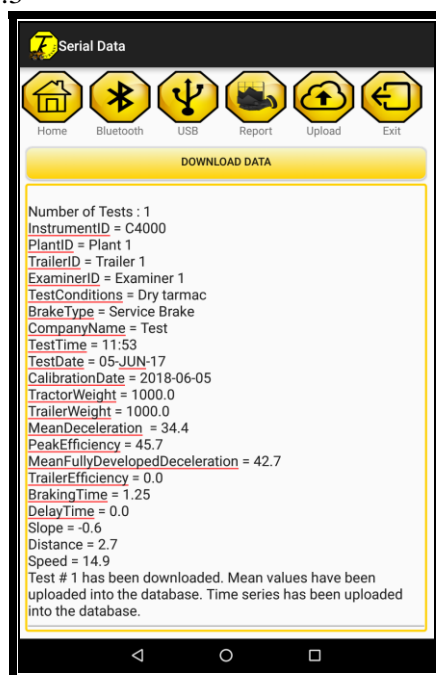

Figure 4.3

4.3 Generate Report

This feature allows you to visualise the historic brake test results and export them to a PDF file (which can be sent to a WiFi printer or shared with anyone via email or other means). Click '**Generate Report**' button and select the instrument from the list. The app will show you the date selection screen as shown in figure 4.4(a). If you wish to search the local database select 'Local Data', otherwise select 'Cloud Data' option to search data from the cloud database. Select the date range and click '**Search Data**' button to show the list of test reports for the selected date range as shown in figure 4.4(b)

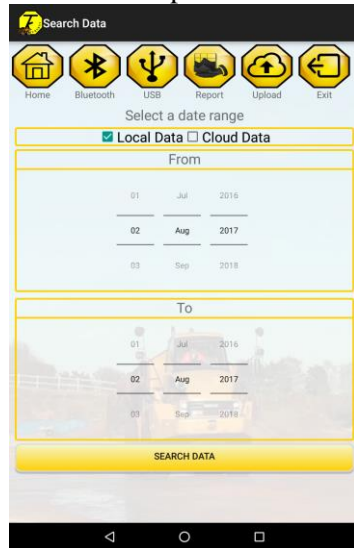

Figure 4.4(a)

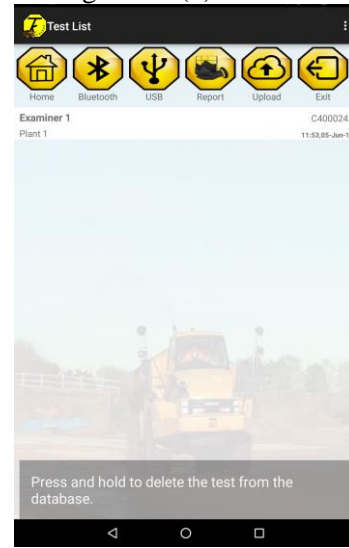

Figure 4.4(b)

Select a test report from the 'Test List' to show the details of the test as shown in figure 4.5(a) and 4.5(b)

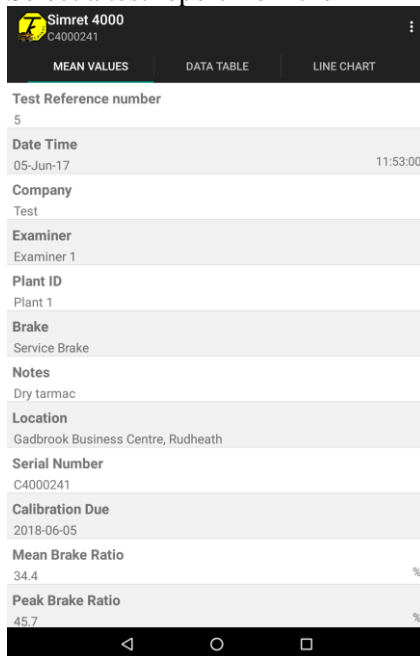

Figure 4.5(a)

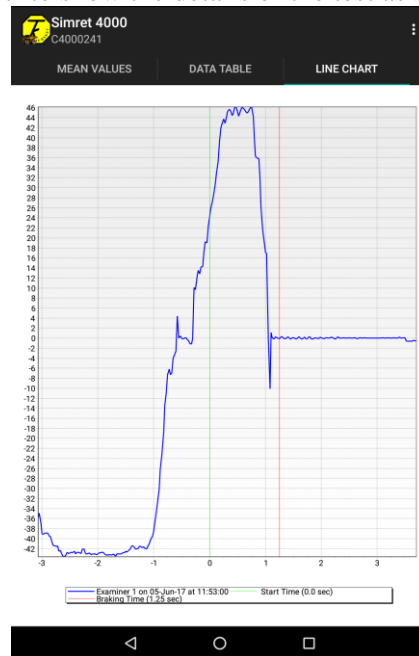

Figure 4.5(b)

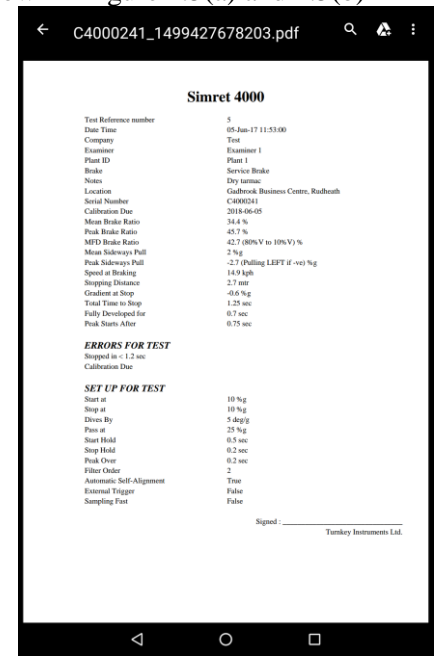

Figure 4.5(c)

Figure 4.5(c) shows the PDF report of the test which can be shared with anyone and printed directly from the mobile device via a WiFi printer. Click '**Options**' and select '**Save to PDF**' to generate report.

4.4 Upload to Cloud

This option allows you to upload all the brake test results to the cloud database which can be used in the WinSim Desktop program to generate reports on the PC.

4.6 Exit

This will exit the application and close all the Bluetooth connections.

4.7 Caveats and Exceptions

If the application crashes or does not display the data please contact support.